

NF3AE Series

User's Manual

NO. G03-NF3AE-F

Revision: 5.0

Release date: December 13, 2022

Trademark:

- * Specifications and Information contained in this documentation are furnished for information use only, and are subject to change at any time without notice, and should not be construed as a commitment by manufacturer.**

Environmental Protection Announcement

Do not dispose this electronic device into the trash while discarding. To minimize pollution and ensure environment protection of mother earth, please recycle.



TABLE OF CONTENT

ENVIRONMENTAL SAFETY INSTRUCTION	iv
USER'S NOTICE	v
MANUAL REVISION INFORMATION	v
CHAPTER 1 INTRODUCTION OF THE MOTHERBOARD	
1-1 FEATURE OF MOTHERBOARD	1
1-2 SPECIFICATION	2
1-3 LAYOUT DIAGRAM	3
CHAPTER 2 HARDWARE INSTALLATION	
2-1 JUMPER SETTING.....	9
2-2 CONNECTORS AND HEADERS	15
2-2-1 CONNECTORS	15
2-2-2 HEADERS	18
CHAPTER 3 INTRODUCING BIOS	
3-1 ENTERING SETUP.....	25
3-2 BIOS MENU SCREEN	26
3-3 FUNCTION KEYS.....	27
3-4 GETTING HELP.....	27
3-5 MEMU BARS.....	28
3-6 MAIN MENU	29
3-7 ADVANCED MENU	30
3-8 CHIPSET MENU	41
3-9 SECURITY MENU	44
3-10 BOOT MENU	45
3-11 SAVE & EXIT MENU	46



Environmental Safety Instruction

- Avoid the dusty, humidity and temperature extremes. Do not place the product in any area where it may become wet.
- 0 to 60 centigrade is the suitable temperature. (The figure comes from the request of the main chipset)
- Generally speaking, dramatic changes in temperature may lead to contact malfunction and crackles due to constant thermal expansion and contraction from the 'welding spots' that connect components and PCB. Computer should go through an adaptive phase before it boots when it is moved from a cold environment to a warmer one to avoid condensation phenomenon. These water drops attached on PCB or the surface of the components can bring about phenomena as minor as computer instability resulted from corrosion and oxidation from components and PCB or as major as short circuit that can burn the components. Suggest starting the computer until the temperature goes up.
- The increasing temperature of the capacitor may decrease the life of computer. Using the close case may decrease the life of other device because the higher temperature in the inner of the case.
- Attention to the heat sink when you over-clocking. The higher temperature may decrease the life of the device and burned the capacitor.

USER'S NOTICE

COPYRIGHT OF THIS MANUAL BELONGS TO THE MANUFACTURER. NO PART OF THIS MANUAL, INCLUDING THE PRODUCTS AND SOFTWARE DESCRIBED IN IT MAY BE REPRODUCED, TRANSMITTED OR TRANSLATED INTO ANY LANGUAGE IN ANY FORM OR BY ANY MEANS WITHOUT WRITTEN PERMISSION OF THE MANUFACTURER.

THIS MANUAL CONTAINS ALL INFORMATION REQUIRED TO USE THIS MOTHER-BOARD SERIES AND WE DO ASSURE THIS MANUAL MEETS USER'S REQUIREMENT BUT WILL CHANGE, CORRECT ANY TIME WITHOUT NOTICE. MANUFACTURER PROVIDES THIS MANUAL "AS IS" WITHOUT WARRANTY OF ANY KIND, AND WILL NOT BE LIABLE FOR ANY INDIRECT, SPECIAL, INCIDENTAL OR CONSEQUENTIAL DAMAGES (INCLUDING DAMAGES FOR LOSS OF PROFIT, LOSS OF BUSINESS, LOSS OF USE OF DATA, INTERRUPTION OF BUSINESS AND THE LIKE).

PRODUCTS AND CORPORATE NAMES APPEARING IN THIS MANUAL MAY OR MAY NOT BE REGISTERED TRADEMARKS OR COPYRIGHTS OF THEIR RESPECTIVE COMPANIES, AND THEY ARE USED ONLY FOR IDENTIFICATION OR EXPLANATION AND TO THE OWNER'S BENEFIT, WITHOUT INTENT TO INFRINGE.

Manual Revision Information

Reversion	Revision History	Date
5.0	Fifth Edition	December 13, 2022

Chapter 1

Introduction of the Motherboard

1-1 Feature of Motherboard

- Onboard Intel® Bay Trail Series Processor, with low power consumption never denies high performance
- Support single channel DDR3L 1333 MHz SODIMM, up to 8GB
- Support 1 * SATAII device
- Onboard one full-size mSATA/ Mini-PCIE slot
- Onboard one half-size Mini-PCIE slot
- Onboard 2 * RJ-45 gigabit Ethernet LAN port
- Integrated with 1 * 24-bit dual channel LVDS header
- Integrated with 4-Lane eDP header
- Support VGA output
- Support USB 3.0 data transport demand
- Support CPU Smart FAN
- Compliance with ErP standard
- Support Watchdog function

1-2 Specification

Spec	Description
Design	<ul style="list-style-type: none"> ● 3.5" SBC; 6 layers; PCB size: 14.8x 10.2 cm
Embedded CPU	<ul style="list-style-type: none"> ● Intel® Bay Trail-D/M/I series CPU <p><i>*CPU model varies from different IPC options. Please consult your dealer for more information of onboard CPU.</i></p>
Memory Slot	<ul style="list-style-type: none"> ● 1 * DDRIII SODIMM Slot for un-buffered Single Channel DDRIII 1333 MHz SDRAM, up to 8GB
Expansion Slot	<ul style="list-style-type: none"> ● Full-size Mini-PCIE/mSATA slot x1 ● Half-size Mini-PCIE slot x1
LAN Chip	<ul style="list-style-type: none"> ● Integrated with dual Realtek RTL8111G PCI-E Gigabit LAN chips ● Support Fast Ethernet LAN function of providing 10/100/1000Mbps Ethernet data transfer rate
Audio Chip	<ul style="list-style-type: none"> ● Realtek HD audio chip ● Audio driver and utility included
BIOS	<ul style="list-style-type: none"> ● AMI 64MB Flash ROM
Rear I/O	<ul style="list-style-type: none"> ● 3* USB 2.0 port ● 2* RJ-45 LAN port ● 1* VGA port ● 1* USB 3.0 port ● Audio Line Out port x1 ● 9V~24V DC Jack
Internal I/O	<ul style="list-style-type: none"> ● 1* SATAII 3Gb/s port ● 1* SATA Power connector ● 1* CPU FAN header ● 1* LVDS inverter ● 1* Front panel audio header

	<ul style="list-style-type: none">● 1* SPDIF Out header● 4* Serial port header● 2* 9-pin USB 2.0 header (Expansible to 4* USB 2.0 ports)● 1* GPIO header● 1* SM_BUS header● 1* PS2KBMS header● 1* Front panel header● 2* LAN LED activity header● 1* LVDS header● 1* 4-Lane eDP header
--	---

1-3 Layout Diagram

Rear IO Panel Diagram:

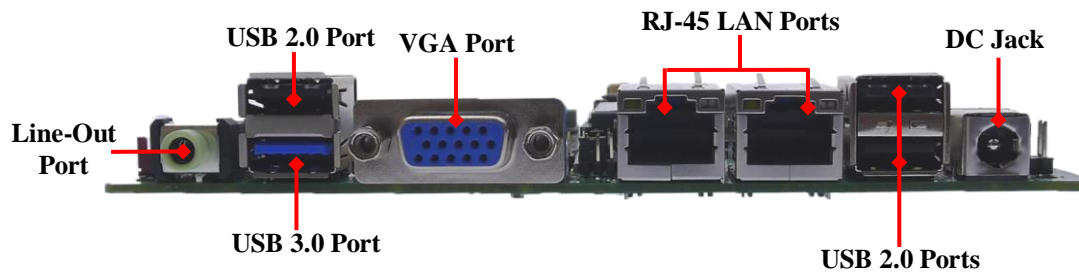

Internal Diagram-Front Side:

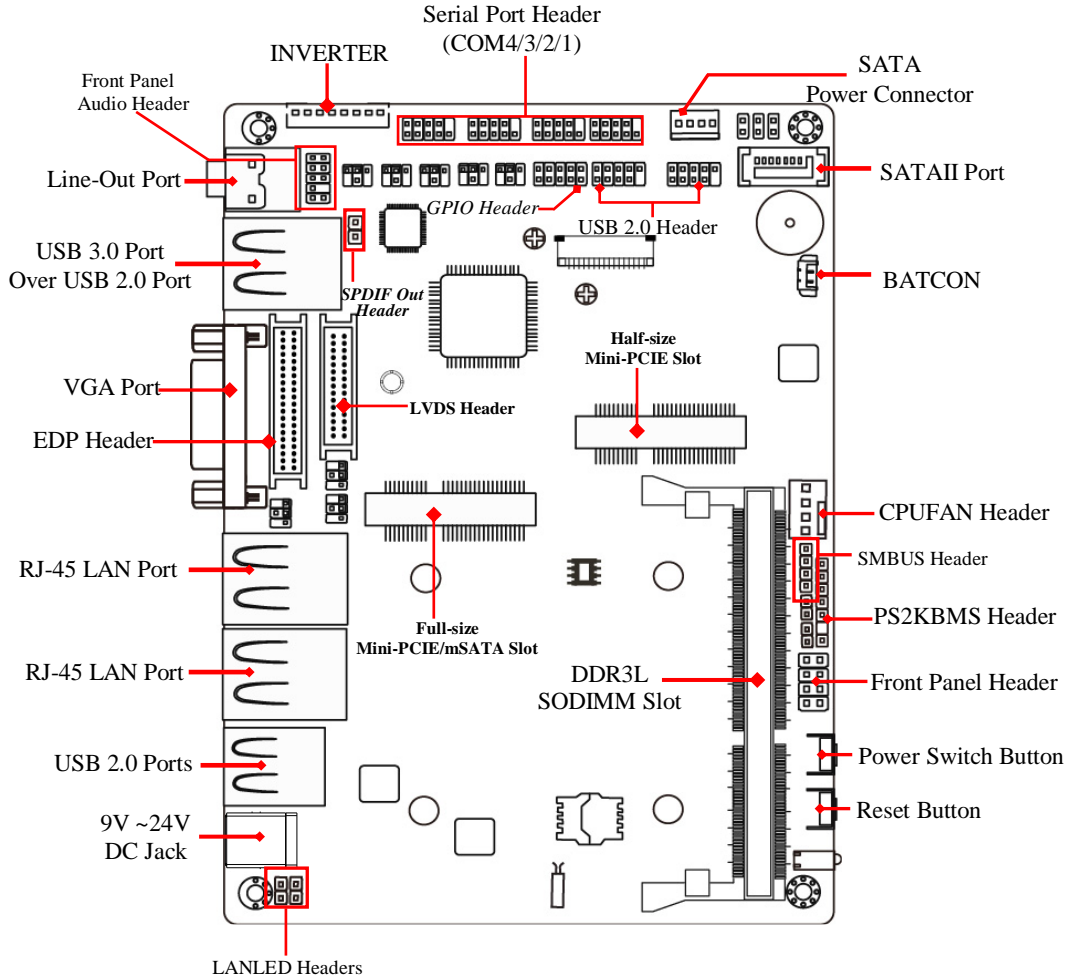

Internal Diagram-Back Side:

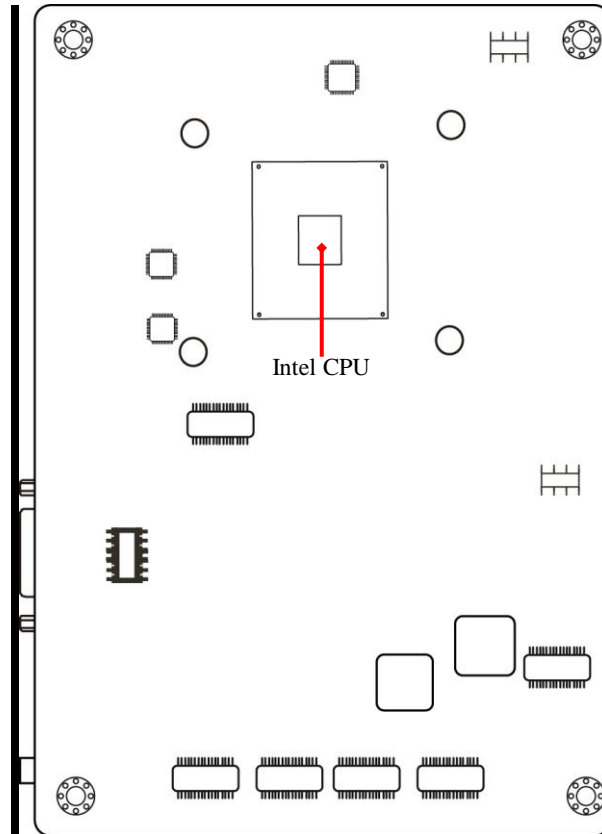

Jumper Position:

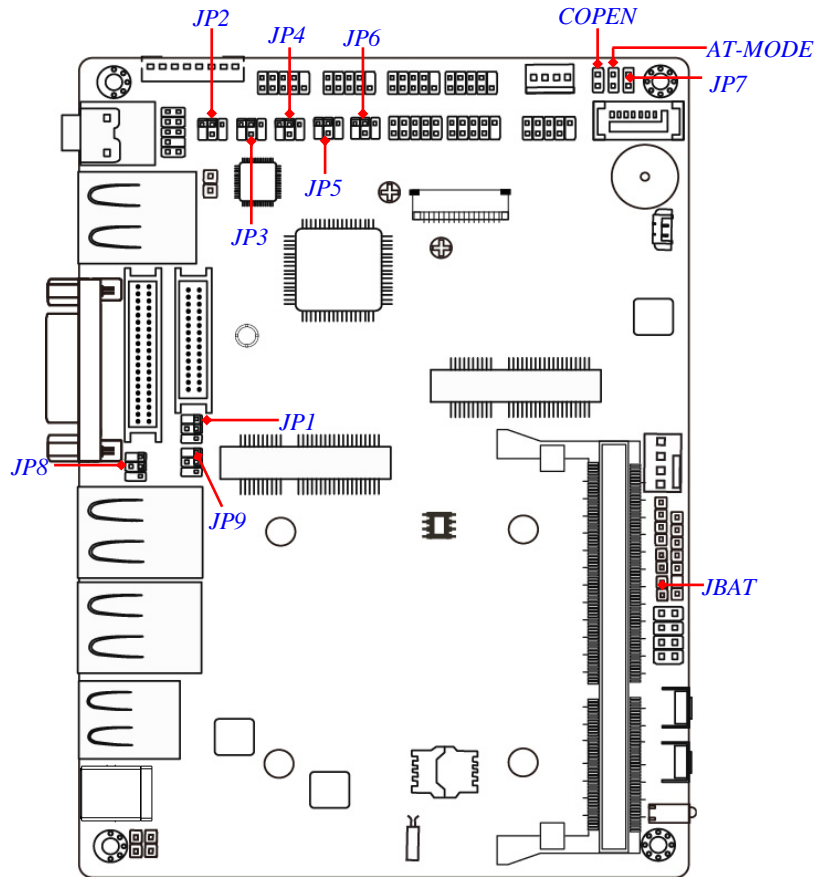

Jumper

Jumper	Name	Description
JP1	LVDS LCD VCC 3.3V/5V/12V Select	4-Pin Block
JP2	LVDS INVERTER VCC 5V/12V/Adapter VCC Select	4-Pin Block
JP8	eDP LCD VCC 3.3V/5V/12V Select	4-Pin Block
JP9	eDP Backlight VCC 5V/12V/ Adapter VCC Select	4-Pin Block
JP3	COM4 Header Pin9 Function Select	4-Pin Block
JP4	COM3 Header Pin9 Function Select	4-Pin Block
JP5	COM2 Header Pin9 Function Select	4-Pin Block
JP6	COM1 Header Pin9 Function Select	4-Pin Block
JBAT	CMOS RAM Clear Function Setting	2-Pin Block
COPEN	Case Open Message Display Function	2-Pin Block
AT_MODE	AT Mode Function Select	2-Pin Block
JP7	Security Measure Function Select	2-Pin Block

Connectors

Connector	Name
SATA1	SATAII Port Connector
PWROUT	SATA Power out Connector
CPUFAN	CPUFAN Connector
INVERTER	LVDS Inverter Connector
USB1/USB3(Top)	USB 2.0 Port Connector X3
USB3(Bottom)	USB 3.0 Port Connectors X1
LAN1/2	RJ-45 LAN Port Connector X2
VGA	VGA Port Connector
AUDIO	Audio Line Out Connector

Headers

Header	Name	Description
FP_AUDIO	Front Panel Audio Header	9-pin Block
SPDIFOUT	SPDIF Out Header	2-pin Block
COM1/2/3/4	Serial Port Header X4	9-pin Block
GPIO	GPIO Header	10-pin Block
USB3/ USB4	USB 2.0 Header	9-pin Block
SMBUS	SMBUS Header	4-pin Block
PS2KBMS	PS2KBMS Header	6-pin Block
FP	Front Panel Header(PWR LED/ HDD LED/Power Button /Reset)	8-pin Block
LAN1LED/LAN2LED	LAN Activity LED Headers	2-pin Block
LVDS	24-bit LVDS Header	30-pin Block
EDP	4-Lane eDP Header	40-pin Block

Chapter 2

Hardware Installation

2-1 Jumper Setting

(1) JP1 (4-pin): LVDS LCD VCC 3.3V/5V/12V Select

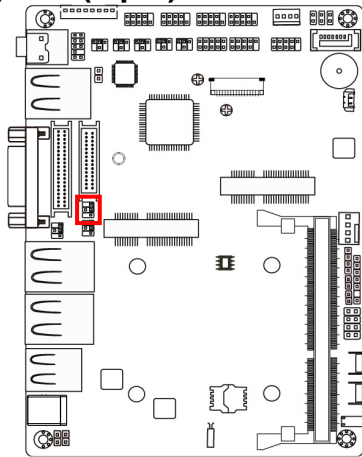

JP1→LVDS LCD VCC

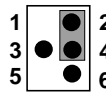

2-4 Closed: LVDS
LCD VCC= 3.3V;

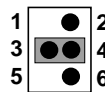

3-4 Closed: LVDS
LCD VCC= 5V;

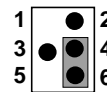

4-6 Closed: LVDS
LCD VCC= 12V.

(2) JP2 (4-pin): LVDS INVERTER VCC 5V/12V/Adapter VCC Select

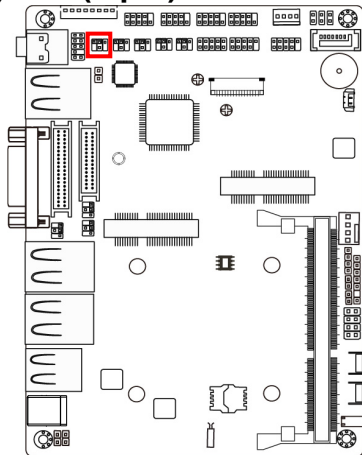

JP2→LVDS Inverter VCC

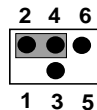

2-4 Closed:
Inverter VCC =5V;

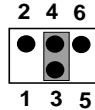

3-4 Closed:
Inverter VCC =12V;

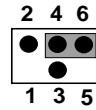

4-6 Closed:
Inverter VCC
=Adapter VCC.

(3) JP8 (4-pin): eDP LCD VCC 3.3V/5V/12V Select

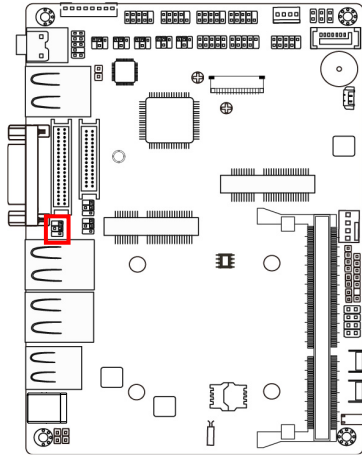

JP8→eDP LCD VCC

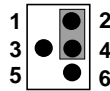

2-4 Closed: eDP
LCD VCC= 3.3V;

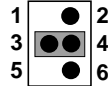

3-4 Closed: eDP
LCD VCC= 5V;

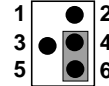

4-6 Closed: eDP
LCD VCC= 12V.

(4) JP9 (4-pin): eDP Backlight VCC 3.3V/5V/Adapter VCC Select

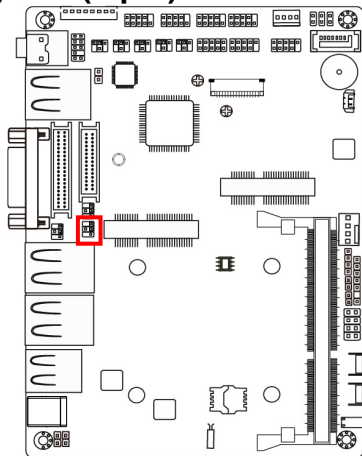

JP9→eDP Backlight VCC

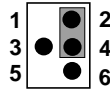

2-4 Closed: eDP
Backlight VCC= 5V;

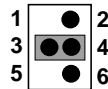

3-4 Closed: eDP
Backlight VCC= 12V;

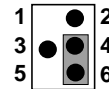

4-6 Closed:
eDP Backlight VCC
= Adapter VCC.

(5) JP3 (4-pin): COM4 Header Pin9 Function Select

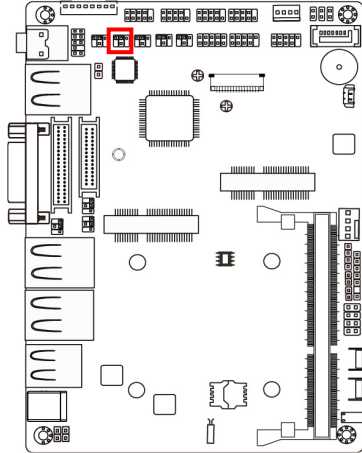

JP3→COM4

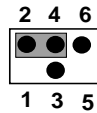

**2-4 Closed:
RI=RS232;**

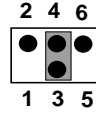

**3-4 Closed:
RI= 5V;**

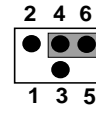

**4-6 Closed:
RI= 12V.**

(6) JP4 (4-pin): COM3 Header Pin9 Function Select

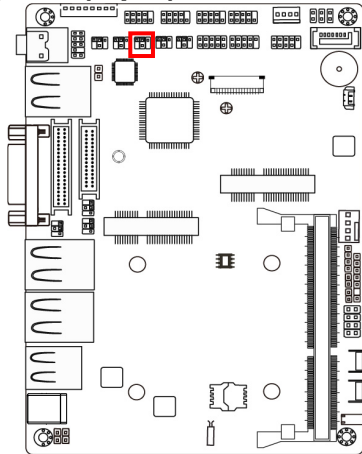

JP4→COM3

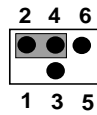

**2-4 Closed:
RI=RS232;**

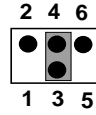

**3-4 Closed:
RI= 5V;**

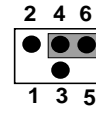

**4-6 Closed:
RI= 12V.**

(7) JP5 (4-pin): COM2 Header Pin9 Function Select

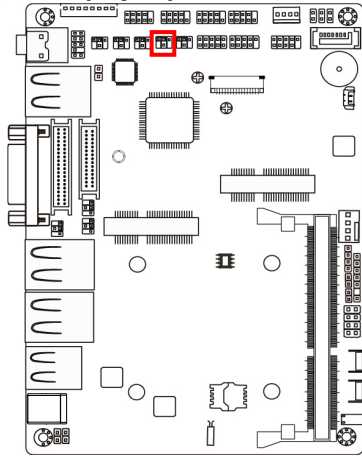

JP5→COM2

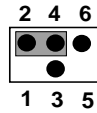

2-4 Closed:
RI=RS232;

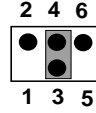

3-4 Closed:
RI= 5V;

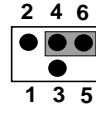

4-6 Closed:
RI= 12V.

(8) JP6 (4-pin): COM1 Header Pin9 Function Select

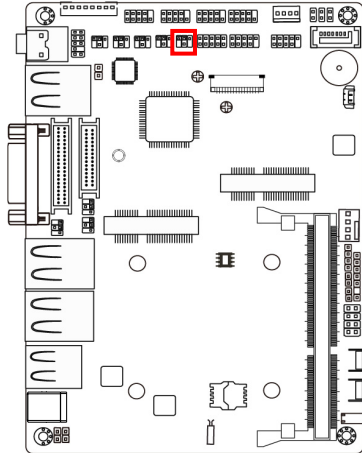

JP6→COM1

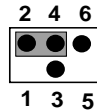

2-4 Closed:
RI=RS232;

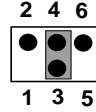

3-4 Closed:
RI= 5V;

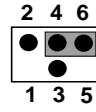

4-6 Closed:
RI= 12V.

(9) JBAT (2-pin): Clear CMOS

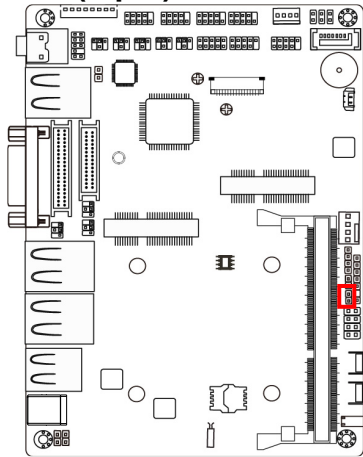

JBAT



1-2 Open: Normal;



1-2 Closed: Clear CMOS

CMOS Clear Setting

(10) COPEN (2-pin): Case Open Message Display Function Select

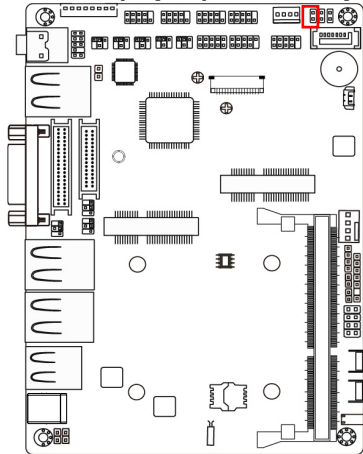

COPEN



Pin 1-2 Closed: When Case open function pin short to GND, the Case open function was detected. When Used, needs to enter BIOS and enable 'Case Open Detect' function. In this case if your case is removed, next time when you restart your computer, a message will be displayed on screen to inform you of this.

(11)AT_MODE (2-pin): AT Mode Function Select

Pin 1-2 closed: AT_MODE function is enabled. In this case your computer will automatically turns on after a sudden power failure when power supply resumes.

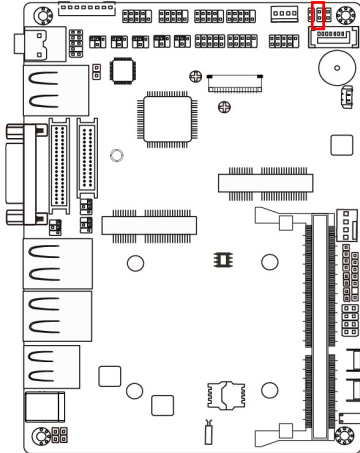

AT_MODE



1-2 Open: ATX Mode Selected;



1-2 Closed: AT Mode Selected

(12)JP7 (2-pin): Security Measure Function Select

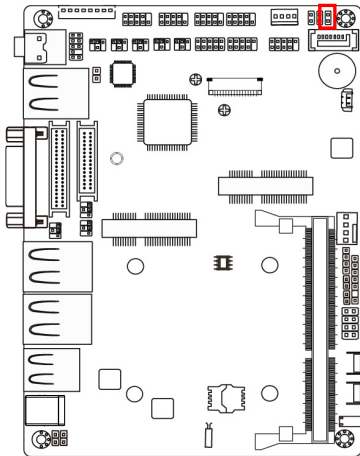

JP7



1-2 Open:Enable Security Measures
in the Flash Descriptor(Default);



1-2 Closed: Disable Security Measures
in the Flash Descriptor(Override).

2-2 Connectors and Headers

2-2-1 Connectors

(1) Rear I/O Connectors

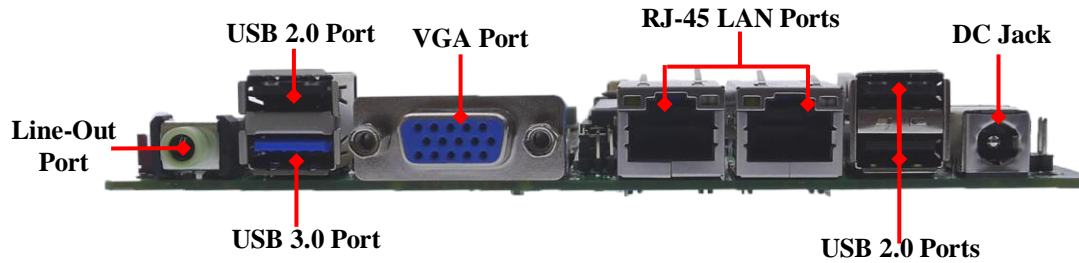

(2) SATA1(7-pin): SATAII Port connector

SATA1 port is a high-speed SATAII port that supports 3GB/s transfer rate.

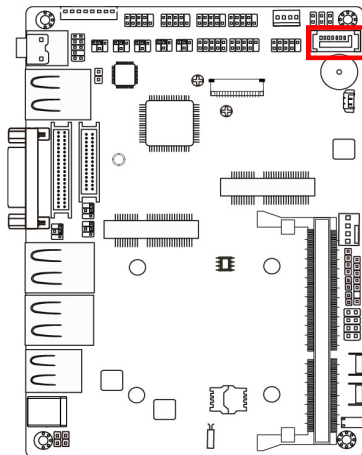

Pin No.	Definition
1	GND
2	TXP
3	TXN
4	GND
5	RXN
6	RXP
7	GND



(3) PWROUT (4-pin): SATA Power Connector

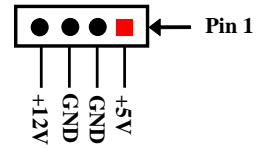
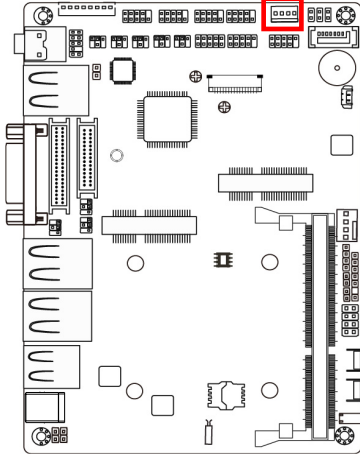

(4) CPUFAN (4-pin): CPUFAN Connector

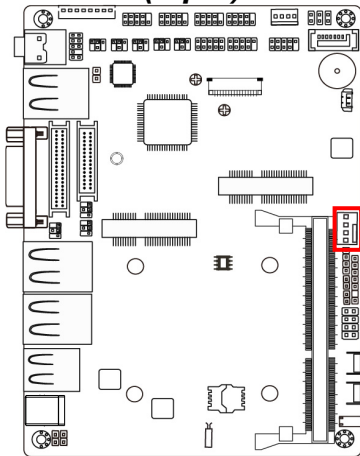

CPUFAN1

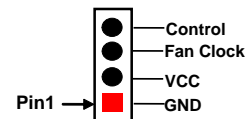

(5) INVERTER (8-pin): LVDS Inverter Connector

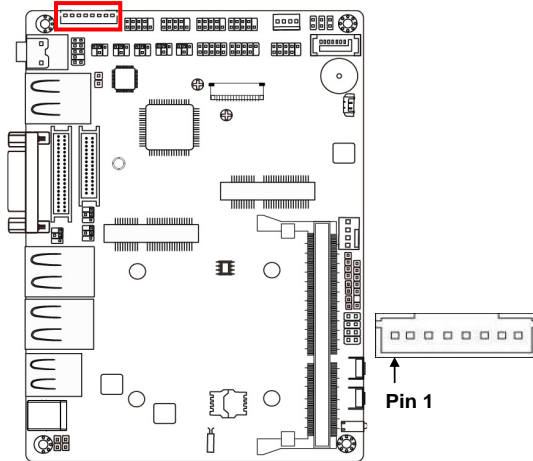

Pin No.	Definition
1	Backlight Enable
2	Backlight PWM
3	PVCC
4	PVCC
5	GND
6	GND
7	Backlight Up SW
8	Backlight Down SW

(6) BATCON (2-pin): Battery Connector

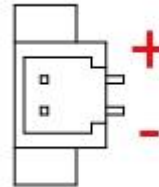
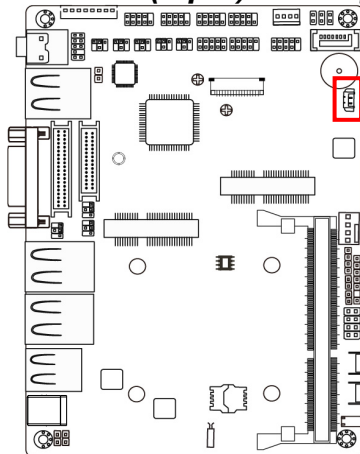

2-2-2 Headers

(1) FP_AUDIO (9-pin): Line-Out, MIC-In Header

This header connects to Front Panel Line-out, MIC-In connector with cable.

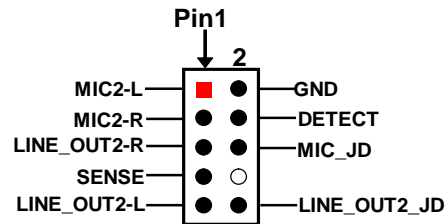
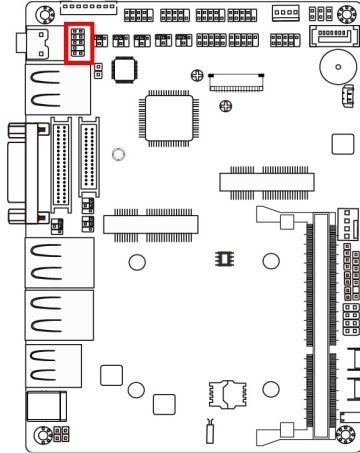

Line-Out, MIC Header

(2) SPDIFOUT (2-pin): SPDIF Out Header

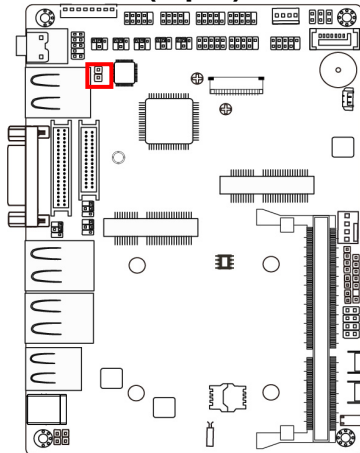

(3) COM4/3/2/1 (9-pin): Serial Port Headers

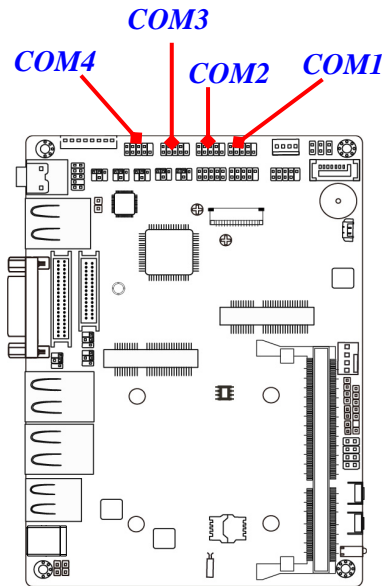

Pin NO.	RS232	*RS422 (for COM1)	*RS485 (for COM1)
Pin 1	DCD	TX-	DATA-
Pin 2	RXD	TX+	DATA+
Pin 3	TXD	RX+	NC
Pin 4	DTR	RX-	NC
Pin 5	GNG	GND	GND
Pin 6	DSR	NC	NC
Pin 7	RTS	NC	NC
Pin 8	CTS	NC	NC
Pin 9	RI	NC	NC

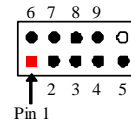

***Notice:** RS422, RS485 function is supported by COM1 header only, with compatible COM cable for RS422 or RS 485 function. User also needs to go to BIOS to set 'Transmission Mode Select' for COM1 (refer to Page 32).

(4) GPIO (10-pin): GPIO Header

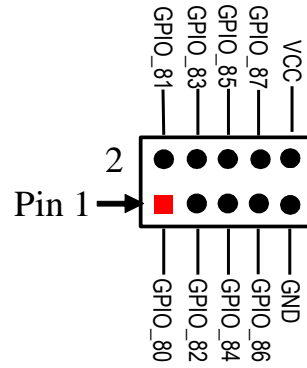
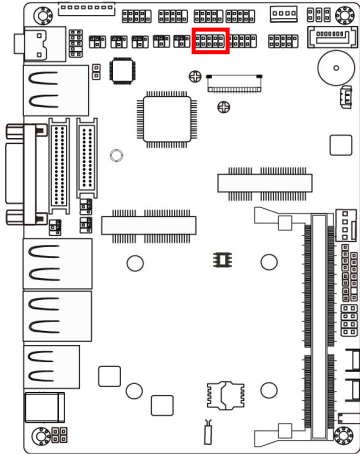

(5) USB2/USB4 (9-pin): USB 2.0 Port Header

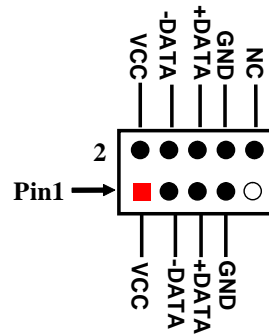
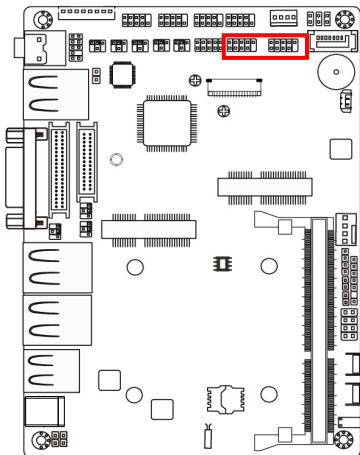

(6) SMBUS (4-Pin): SM BUS Header

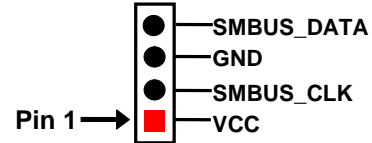
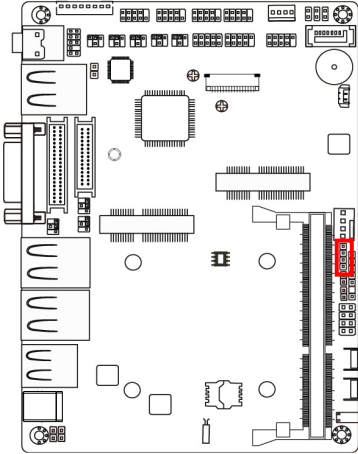

(7) PS2KBMS (6-pin): PS/2 Keyboard & Mouse Header

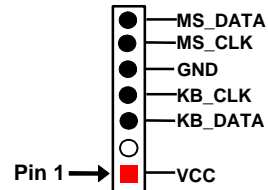
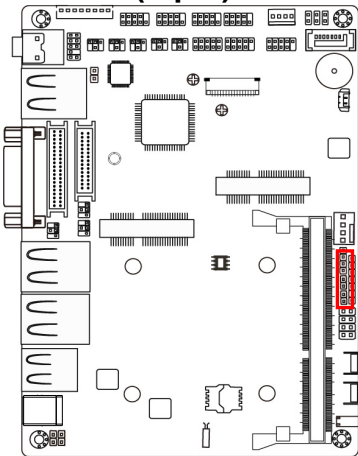

(8) FP (8-pin): Front Panel Header

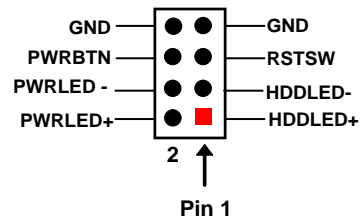
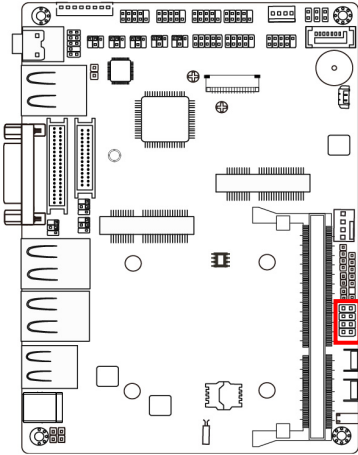

(9) LAN1LED/LAN2LED (2-pin): LAN Activity LED Headers

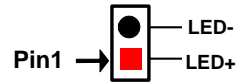
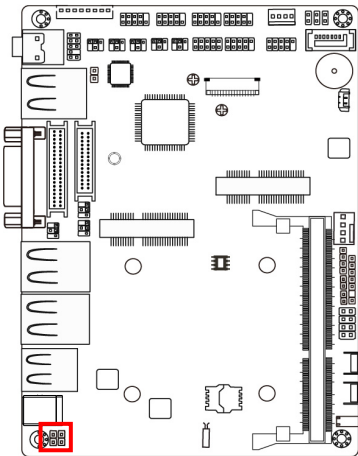

LAN1LED/LAN2LED

(10) LVDS (30-pin): 24-bit Dual Channel LVDS Header

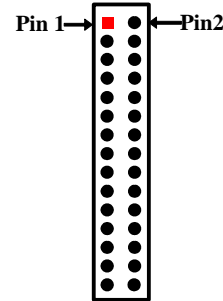
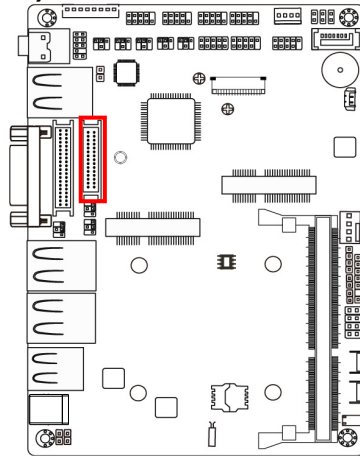

Pin NO.	Pin Define	Pin NO.	Pin Define
Pin 1	LVDSB_DATAN3	Pin 2	LVDSB_DATAP3
Pin 3	LVDS_CLKBN	Pin 4	LVDS_CLKBP
Pin 5	LVDSB_DATAN2	Pin 6	LVDSB_DATAP2
Pin 7	LVDSB_DATAN1	Pin 8	LVDSB_DATAP1
Pin 9	LVDSB_DATAN0	Pin 10	LVDSB_DATAP0
Pin 11	NC/DDC_DATA	Pin 12	NC/DDC_CLK
Pin 13	GND	Pin 14	GND
Pin 15	GND	Pin 16	GND
Pin 17	LVDSA_DATAP3	Pin 18	LVDSA_DATAN3
Pin 19	LVDS_CLKAP	Pin 20	LVDS_CLKAN
Pin 21	LVDSA_DATAP2	Pin 22	LVDSA_DATAN2
Pin 23	LVDSA_DATAP1	Pin 24	LVDSA_DATAN1
Pin 25	LVDSA_DATAP0	Pin 26	LVDSA_DATAN0
Pin 27	PVCC	Pin 28	PVCC
Pin 29	PVCC	Pin 30	PVCC

(11) eDP (40-pin): eDP Header

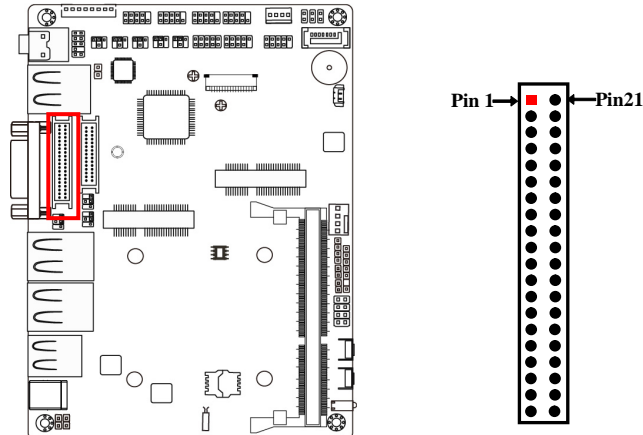

Pin NO.	Pin Define	Pin NO.	Pin Define
Pin 1	NC	Pin 21	NC
Pin 2	GND	Pin 22	NC
Pin 3	Lane3_N	Pin 23	GND
Pin 4	Lane3_P	Pin 24	GND
Pin 5	GND	Pin 25	GND
Pin 6	Lane2_N	Pin 26	GND
Pin 7	Lane2_P	Pin 27	HPD
Pin 8	GND	Pin 28	GND
Pin 9	Lane1_N	Pin 29	GND
Pin 10	Lane1_P	Pin 30	GND
Pin 11	GND	Pin 31	GND
Pin 12	Lane0_N	Pin 32	BL_ENABLE
Pin 13	Lane0_P	Pin 33	BL_PWM_DIM
Pin 14	GND	Pin 34	NC
Pin 15	AUX_CH_P	Pin 35	NC
Pin 16	AUX_CH_N	Pin 36	BL_PWR
Pin 17	GND	Pin 37	BL_PWR
Pin 18	LCD_VCC	Pin 38	BL_PWR
Pin 19	LCD_VCC	Pin 39	BL_PWR
Pin 20	LCD_VCC	Pin 40	NC

Chapter 3

Introducing BIOS

Notice! The BIOS options in this manual are for reference only. Different configurations may lead to difference in BIOS screen and BIOS screens in manuals are usually the first BIOS version when the board is released and may be different from your purchased motherboard. Users are welcome to download the latest BIOS version form our official website.

The BIOS is a program located on a Flash Memory on the motherboard. This program is a bridge between motherboard and operating system. When you start the computer, the BIOS program will gain control. The BIOS first operates an auto-diagnostic test called POST (power on self test) for all the necessary hardware, it detects the entire hardware device and configures the parameters of the hardware synchronization. Only when these tasks are completed done it gives up control of the computer to operating system (OS). Since the BIOS is the only channel for hardware and software to communicate, it is the key factor for system stability, and in ensuring that your system performance as its best.

3-1 Entering Setup

Power on the computer and by pressing immediately allows you to enter Setup. If the message disappears before your respond and you still wish to enter Setup, restart the system to try again by turning it OFF then ON or pressing the “RESET” button on the system case. You may also restart by simultaneously pressing <Ctrl>, <Alt> and <Delete> keys. If you do not press the keys at the correct time and the system does not boot, an error message will be displayed and you will again be asked to

Press **** to enter Setup; press **<F7>** for Popup Menu.

3-2 BIOS Menu Screen

The following diagram show a general BIOS menu screen:

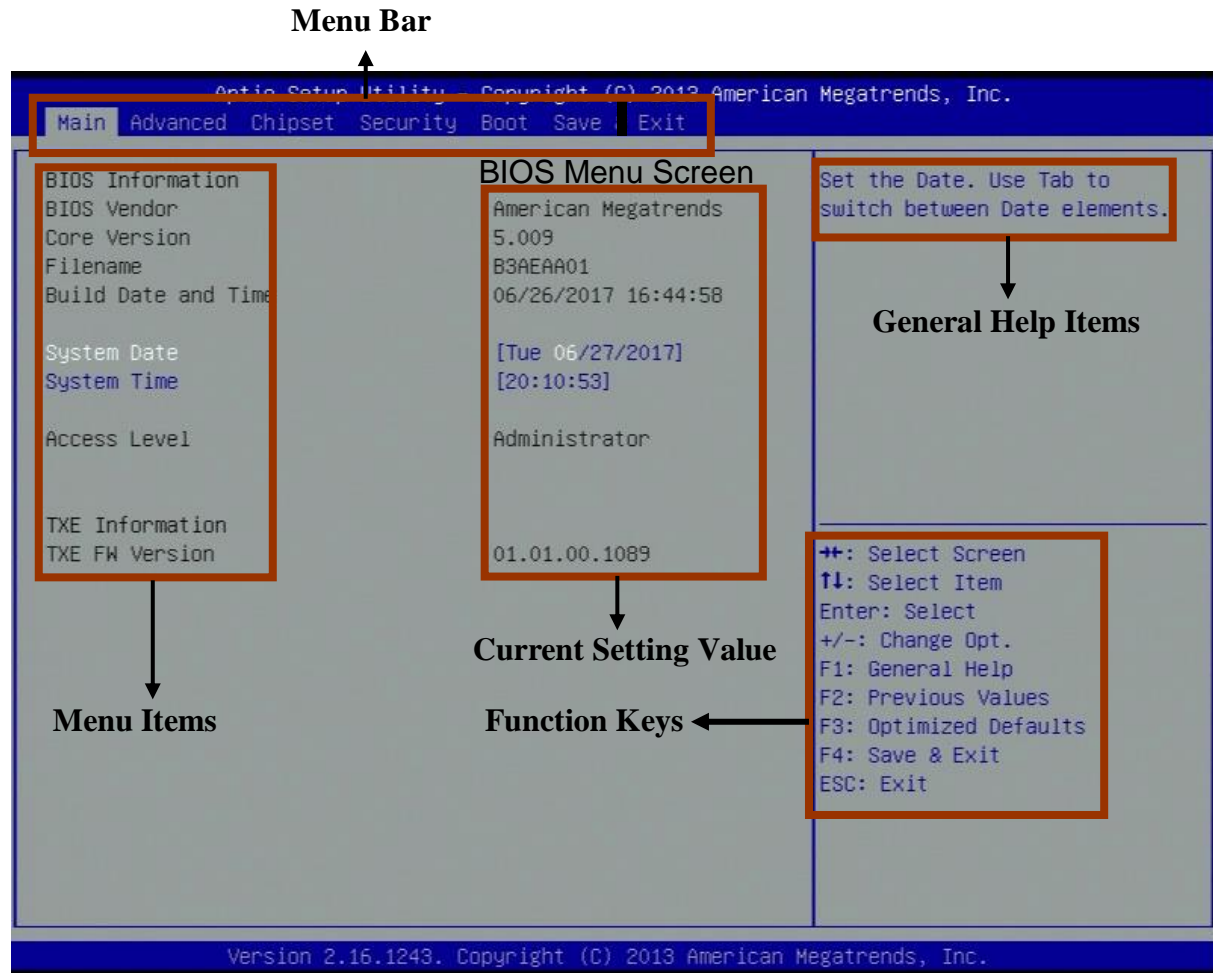

3-3 Function Keys

In the above BIOS Setup main menu of, you can see several options. We will explain these options step by step in the following pages of this chapter, but let us first see a short description of the function keys you may use here:

- Press ←→ (left, right) to select screen;
- Press ↑↓ (up, down) to choose, in the main menu, the option you want to confirm or to modify.
- Press <Enter> to select.
- Press <+>/<-> keys when you want to modify the BIOS parameters for the active option.
- [F1]: General help.
- [F2]: Previous value.
- [F3]: Optimized defaults.
- [F4]: Save & Exit.
- Press <Esc> to quit the BIOS Setup.

3-4 Getting Help

Main Menu

The on-line description of the highlighted setup function is displayed at the top right corner the screen.

Status Page Setup Menu/Option Page Setup Menu

Press F1 to pop up a small help window that describes the appropriate keys to use and the possible selections for the highlighted item. To exit the Help Window, press <Esc>.

3-5 Menu Bars

There are six menu bars on top of BIOS screen:

Main	To change system basic configuration
Advanced	To change system advanced configuration
Chipset	To change chipset configuration
Security	Password settings
Boot	To change boot settings
Save & Exit	Save setting, loading and exit options.

User can press the right or left arrow key on the keyboard to switch from menu bar. The selected one is highlighted.

3-6 Main Menu

Main menu screen includes some basic system information. Highlight the item and then use the <+> or <-> and numerical keyboard keys to select the value you want in each item.

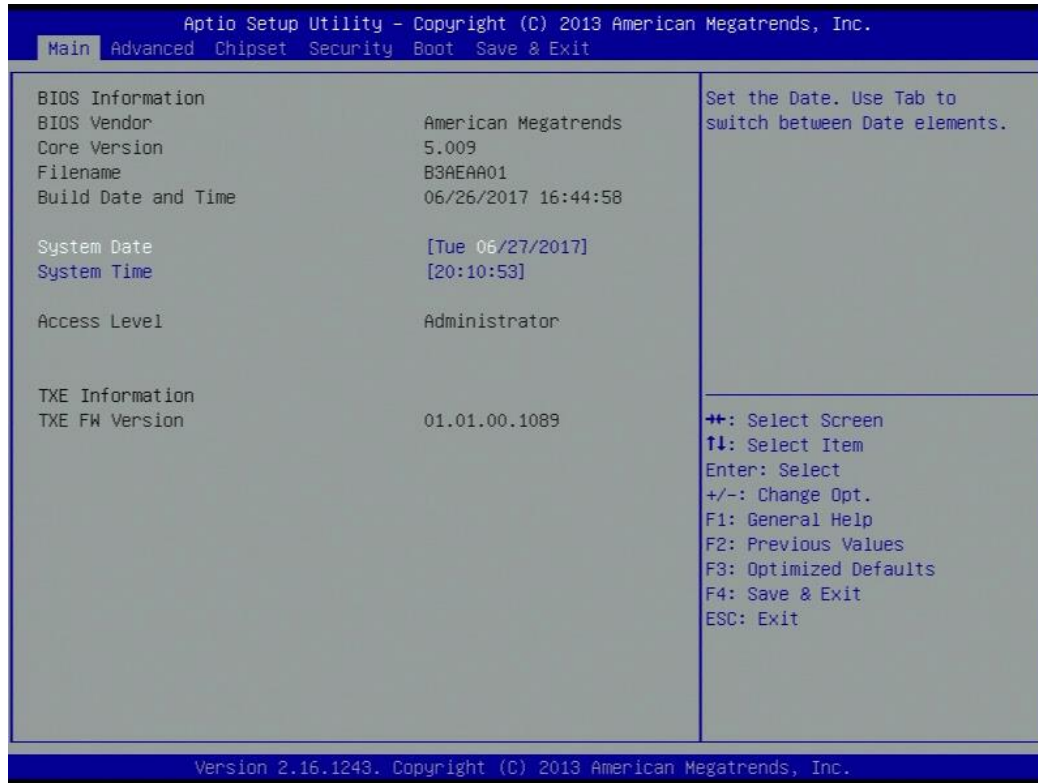

System Date

Set the date. Please use [Tab] to switch between date elements.

System Time

Set the time. Please use [Tab] to switch between time elements.

3-7 Advanced Menu

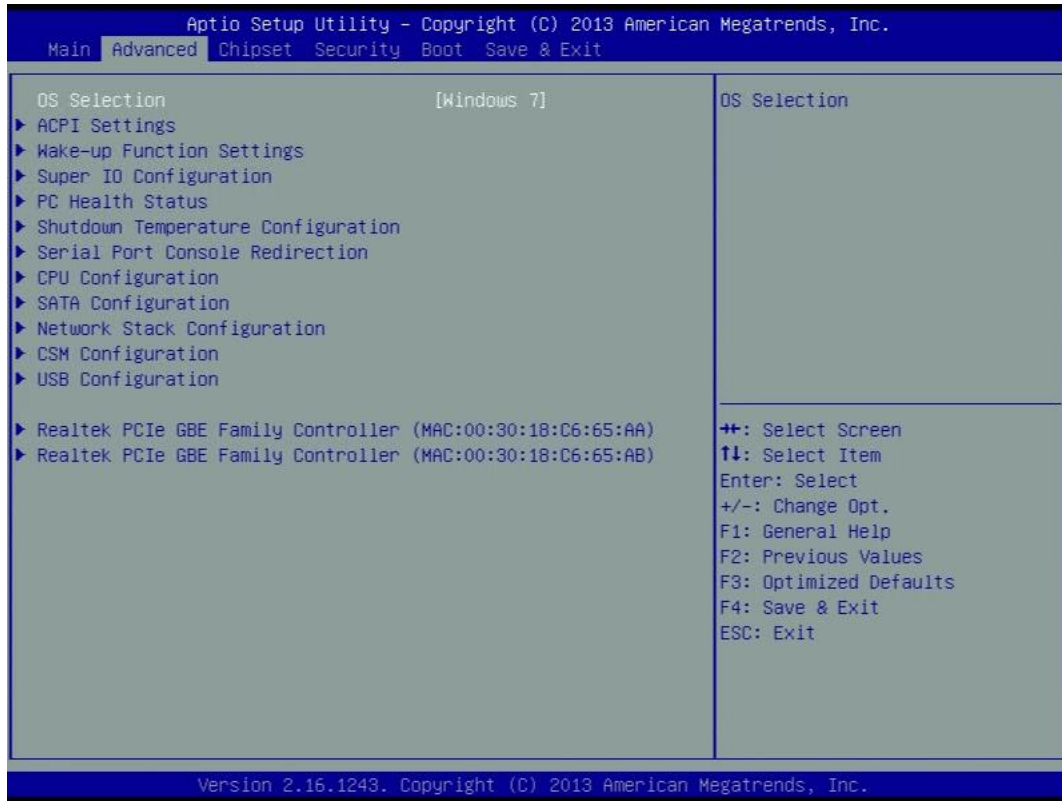

OS Selection

The optional settings: [Linux/Android]; [Windows 8.X]; [Windows 7].

In the case that OS selection is set as [Windows 7], XHCI & EHCI mode will be auto configuration.

***Note:** User need to go to this item to select the OS mode before installing corresponding OS driver, otherwise problems will occur when installing the driver.

▶ **ACPI Settings**

Press [Enter] to make settings for the following sub-item:

ACPI Sleep State

Use this item to select the highest ACPI sleep state the system will enter when the suspend button is pressed.

The optional settings are: [Suspend Disabled]; [S3 (Suspend to RAM)].

▶ **Wake-up Function Settings**

Press [Enter] to make settings for the following sub-items:

Wake-up System with Fixed Time

Use this item to enable or disable system wake on alarm event. When set as [Enabled], system will wake on the hour/min/sec specified.

The optional settings: [Disabled]; [Enabled].

Wake System with Dynamic Time

Use this item to enable or disable system wake on alarm event. When set as [Enabled], system will wake on the current time + increase minute(s).

The optional settings: [Disabled]; [Enabled].

PS2 KB/MS Wakeup

The optional settings: [Disabled]; [Enabled].

Use this item to enable or disable PS2 KB/MS wakeup from S3/S4/S5 state.

**Note: This item will only show when 'ERP Support' is set as [Disabled].*

USB S3/S4 Wake-up

Use this item to enable or disable USB S3/S4 wake-up.

**Note: *This item will only show when 'ERP Support' is set as [Disabled].*

USB S5 Power

Use this item to enable or disable USB power after system shutdown.

**Note: *This item will only show when 'ERP Support' is set as [Disabled].*

▶ **Super I/O Configuration**

Press [Enter] to make settings for the following sub-items:

ERP Function

The optional settings: [Disable]; [Auto].

This item should be set as [Disabled] if you wish to have all active wake-up functions.

▶ **Serial Port 1 Configuration**

Press [Enter] to make settings for the following items:

Serial Port

Use this item to enable or disable serial port (COM).

Change Settings

Use this item to select an optimal setting for super IO device.

The optional settings are: [Auto]; [IO=3F8h; IRQ=4;]; [IO=3F8h; IRQ=3,4,5,6,7,9,10,11]; [IO=2F8h; IRQ=3,4,5,6,7,9,10,11]; [IO=3E8h; IRQ=3,4,5,6,7,9,10,11]; [IO=2E8h; IRQ=3,4,5,6,7,9,10,11].

Transmission Mode Select

The optional settings are: [RS422]; [RS232]; [RS485].

Mode Speed Select

The optional settings are: [RS232/RS422/RS485=250kbps]; [RS232=1Mbps, RS422/RS485=10Mbps].

Serial Port FIFO Mode

The optional settings are: [16-Byte FIFO]; [32-Byte FIFO]; [64-Byte FIFO]; [128-Byte FIFO].

▶ **Serial Port 2 Configuration**

Press [Enter] to make settings for the following items:

Serial Port

Use this item to enable or disable serial port (COM).

Change Settings

Use this item to select an optimal setting for super IO device.

The optional settings are: [Auto]; [IO=2F8h; IRQ=3;]; [IO=3F8h; IRQ=3,4,5,6,7,9,10,11]; [IO=2F8h; IRQ=3,4,5,6,7,9,10,11]; [IO=3E8h; IRQ=3,4,5,6,7,9,10,11]; [IO=2E8h; IRQ=3,4,5,6,7,9,10,11].

Serial Port FIFO Mode

The optional settings are: [16-Byte FIFO]; [32-Byte FIFO]; [64-Byte FIFO]; [128-Byte FIFO].

▶ **Serial Port 3 Configuration**

Press [Enter] to make settings for the following items:

Serial Port

Use this item to enable or disable serial port (COM).

Change Settings

Use this item to select an optimal setting for super IO device.

The optional settings are: [Auto]; [IO=3E8h; IRQ=10;]; [IO=3F8h; IRQ=3,4,5,6,7,9,10,11]; [IO=2F8h; IRQ=3,4,5,6,7,9,10,11]; [IO=3E8h; IRQ=3,4,5,6,7,9,10,11]; [IO=2E8h; IRQ=3,4,5,6,7,9,10,11]; [IO=3E0h; IRQ=3,4,5,6,7,9,10,11]; [IO=2E0h; IRQ=3,4,5,6,7,9,10,11].

Serial Port FIFO Mode

The optional settings are: [16-Byte FIFO]; [32-Byte FIFO]; [64-Byte FIFO]; [128-Byte FIFO].

▶ **Serial Port 4 Configuration**

Press [Enter] to make settings for the following items:

Serial Port

Use this item to enable or disable serial port (COM).

Change Settings

Use this item to select an optimal setting for super IO device.

The optional settings are: [Auto]; [IO=2E8h; IRQ=10;]; [IO=3F8h; IRQ=3,4,5,6,7,9,10,11]; [IO=2F8h; IRQ=3,4,5,6,7,9,10,11]; [IO=3E8h; IRQ=3,4,5,6,7,9,10,11]; [IO=2E8h; IRQ=3,4,5,6,7,9,10,11]; [IO=3E0h; IRQ=3,4,5,6,7,9,10,11]; [IO=2E0h; IRQ=3,4,5,6,7,9,10,11].

Serial Port FIFO Mode

The optional settings are: [16-Byte FIFO]; [32-Byte FIFO]; [64-Byte FIFO]; [128-Byte FIFO].

OS Select For Serial Port

Use this item to select serial port support for Windows or Linux.

The optional settings: [Windows]; [Linux].

WatchDog Timer

Use this item to enable or disable WatchDog Timer Control. When set as

[Enabled], the following sub-items shall appear:

WatchDog Timer Value

User can set a value in the range of 4 to 255.

WatchDog Timer Unit

The optional settings are: [Sec.]; [Min.].

WatchDog Wake-up Timer in ERP

This item support WDT wake-up while ERP function is set as [Auto].

The optional settings are: [Disabled]; [Enabled].

When set as [Enabled], the following sub-items shall appear:

WatchDog Timer Value in ERP

User can set a value in the range of [10] to [4095] seconds, or [1] to [4095] minutes.

WatchDog Timer Unit

The optional settings are: [Sec.]; [Min.].

ATX Power Emulate AT Power

This item support Emulate AT power function, MB power On/Off control by power supply. Use needs to select 'AT or ATX Mode' on MB jumper at first (ATX Mode & AT Mode Select).

Case Open Detect

This item controls detect case open function.

The optional settings are: [Disabled]; [Enabled].

▶ **PC Health Status**

Press [Enter] to view current hardware health status & make further settings in 'Smart Configuration'.

▶ **SmartFan Configuration**

Press [Enter] to make settings for SmartFan Configuration:

CPU Fan Type

The optional settings are: [4-Pin]; [3-Pin].

CPUFAN Smart Mode

The optional settings are: [Disabled]; [Enabled].

When set as [Enabled], the following sub-items shall appear:

CPUFAN Full-Speed Temperature

Use this item to set CPUFAN full speed temperature. Fan will run at full speed when above the pre-set temperature.

CPUFAN Full-Speed Duty

Use this item to set CPUFAN full speed duty. Fan will run at full speed when above the pre-set duty.

CPUFAN Idle-Speed Temperature

Use this item to set CPUFAN idle speed temperature. Fan will run at idle speed when below the pre-set temperature.

CPUFAN Idle-Speed Duty

Use this item to set CPUFAN idle speed duty. Fan will run at idle speed when below the pre-set duty.

▶ **Shutdown Temperature Configuration**

Use this item to select system shutdown temperature.

The optional settings are: [Disabled]; [70° C/158° F]; [75° C/167° F]; [80° C/176° F]; [85° C/185° F].

▶ **Serial Port Consol Redirection**

Press [Enter] to make settings for serial port redirection settings:

COM1

Console Redirection

The optional settings are: [Disabled]; [Enabled].

When set as [Enabled], user can make further settings in:

▶ **Console Redirection Settings**

The settings specify how the host computer and the remote computer (which the user is using) will exchange data. Both computers should have the same or compatible settings.

Press [Enter] to make settings for the following sub-items.

Terminal Type

The optional settings are: [VT100]; [VT100+]; [VT-UTF8]; [ANSI].

Bits per second

The optional settings are: [9600]; [19200]; [38400]; [57600]; [115200].

Data Bits

The optional settings are: [7]; [8].

Parity

The optional settings are: [None]; [Even]; [Odd]; [Mark]; [Space].

Stop Bits

The optional settings are: [1]; [2].

Flow Control

The optional settings are: [None]; [Hardware RTS/CTS].

VT-UTF8 Combo Key Support

The optional settings are: [Disabled]; [Enabled].

Recorder Mode

The optional settings are: [Disabled]; [Enabled].

Resolution 100x31

The optional settings are: [Disabled]; [Enabled].

Legacy OS Redirection Resolution

The optional settings are: [80x24]; [80x25].

Putty Keypad

The optional settings are: [VT100]; [LINUX]; [XTERMR6]; [SCO]; [ESCN]; [VT400].

Redirection After BIOS POST

The optional settings are: [Always Enable]; [BootLoader].

Legacy Console Redirection

▶ **Legacy Console Redirection Settings**

The settings specify how the host computer and the remote computer (which the user is using) will exchange data. Both computers should have the same or compatible settings.

Press [Enter] to select a COM port to display redirection of Legacy OS and Legacy OPROM Messages.

The optional setting is: [COM1].

**Serial Port for Out-of-Band Management/
Windows Emergency Management Services (EMS)
Console Redirection**

The optional settings are: [Disabled]; [Enabled].

When set as [Enabled], user can make further settings in 'Console Redirection Settings':

▶ **Console Redirection Settings**

The settings specify how the host computer and the remote computer (which the user is using) will exchange data. Both computers should have the same or compatible settings.

Press [Enter] to make settings for the following sub-items.

Out-of-Band Mgmt Port

This item may or may not show up, depending on different configuration.

Terminal Type

The optional settings are: [VT100]; [VT100+]; [VT-UTF8]; [ANSI].

Bits per second

The optional settings are: [9600]; [19200]; [57600]; [115200].

Flow Control

The optional settings are: [None]; [Hardware RTS/CTS]; [Software Xon/Xoff].

Data Bits

The default setting is: [8].

**This item may or may not show up, depending on different configuration.*

Parity

The default setting is: [None].

**This item may or may not show up, depending on different configuration.*

Stop Bits

The default setting is: [1].

**This item may or may not show up, depending on different configuration.*

▶ **CPU Configuration**

Press [Enter] to view current CPU configuration and make settings for the following sub-items:

Limit CPUID Maximum

The optional settings: [Disabled]; [Enabled].

This item should be set as [Disabled] for Windows XP.

Execute Disable Bit

The optional settings: [Disabled]; [Enabled].

Hardware Prefetcher

The optional settings are: [Disabled]; [Enabled].

Use this item to turn on/off the Mid Level Cache (L2) streamer prefetcher.

Adjacent Cache Line Prefetch

The optional settings are: [Disabled]; [Enabled].

Use this item to turn on/off prefetching of adjacent cache lines.

Intel Virtualization Technology

The optional settings: [Disabled]; [Enabled].

When set as [Enabled], a VMM can utilize the additional hardware capabilities provided by Vanderpool Technology.

EIST

The optional settings: [Disabled]; [Enabled].

Use this item to enable or disable Intel SpeedStep.

▶ **SATA Configuration**

Press [Enter] to make settings for the following sub-items:

SATA Configuration

SATA Port

The optional settings: [Enabled]; [Disabled].

SATA Mode

The optional settings are: [IDE Mode]; [AHCI Mode].

SATA Speed Support

The item is for user to set the maximum speed the SATA controller can support.

The optional settings are: [Gen1]; [Gen2].

SATA Port

The optional settings are: [Enabled]; [Disabled].

mSATA

The optional settings are: [Enabled]; [Disabled].

▶ **Network Stack Configuration**

Press [Enter] to go to '**Network Stack**' screen to make further settings.

Network Stack

The optional settings are: [Disabled]; [Enabled].

When set as [Enabled], the following sub-items shall appear:

Ipv4 PXE Support

The optional settings are: [Disabled]; [Enabled].

Use this item to enable Ipv4 PXE Boot Support. When set as [Disabled], Ipv4 boot optional will not be created.

Ipv6 PXE Support

The optional settings are: [Disabled]; [Enabled].

Use this item to enable Ipv6 PXE Boot Support. When set as [Disabled], Ipv6 boot optional will not be created.

PXE boot wait time

Use this item to set wait time to press [ESC] key to abort the PXE boot.

▶ **CSM Configuration**

Press [Enter] to make settings for the following sub-items:

Option ROM execution order

Network

This item controls the execution of UEFI and legacy PXE OpROM.

The optional settings are: [Do not launch]; [UEFI only]; [Legacy only].

Storage

This item controls the execution of UEFI and Legacy Storage OpROM.

The optional settings are: [Do not launch]; [UEFI only]; [Legacy only]; [Legacy first]; [UEFI first].

Other PCI devices

This item determines OpROM execution policy for devices other than Network, storage or video.

The optional settings are: [UEFI first]; [Legacy Only].

▶ **USB Configuration**

Press [Enter] to make settings for the following sub-items:

USB Configuration

Legacy USB Support

The optional settings are: [Enabled]; [Disabled]; [Auto].

[Enabled]: To enable legacy USB support.

[Disabled]: To keep USB devices available only for EFI specification,

[Auto]: To disable legacy support if no USB devices are connected.

XHCI Hand-off

This is a workaround for OSES without XHCI hand-off support. The XHCI ownership change should be claimed by XHCI driver.

The optional settings are: [Enabled]; [Disabled].

EHCI Hand-off

This is a workaround for OSES without EHCI hand-off support. The EHCI ownership change should be claimed by EHCI driver.

The optional settings are: [Disabled]; [Enabled].

USB Mass Storage Driver Support

The optional settings are: [Disabled]; [Enabled].

USB hardware delay and time-outs:

USB Transfer time-out

Use this item to set the time-out value for Control, Bulk, and Interrupt transfers.

The optional settings are: [1 sec]; [5 sec]; [10 sec]; [20 sec].

Device reset time-out

Use this item to set USB mass storage device Start Unit command time-out.

The optional settings are: [10 sec]; [20 sec]; [30 sec]; [40 sec].

Device power-up delay

Use this item to set maximum time the device will take before it properly reports itself to the host controller. 'Auto' uses default value: for a root port it is 100 ms, for a hub port the delay is taken from hub descriptor.

The optional settings: [Auto]; [Manual].

Select [Manual] you can set value for the following sub-item: ‘**Device Power-up delay in seconds**’.

Device Power-up delay in seconds

The delay range is from 1 to 40 seconds, in one second increments.

- ▶ **Realtek PCIe GBE Family Controller (MAC:XX:XX:XX:XX:XX:XX)**
Use this item to get driver information and configure Realtek ethernet controller parameter.
- ▶ **Realtek PCIe GBE Family Controller (MAC:XX:XX:XX:XX:XX:XX)**
Use this item to get driver information and configure Realtek ethernet controller parameter.

3-8 Chipset Menu

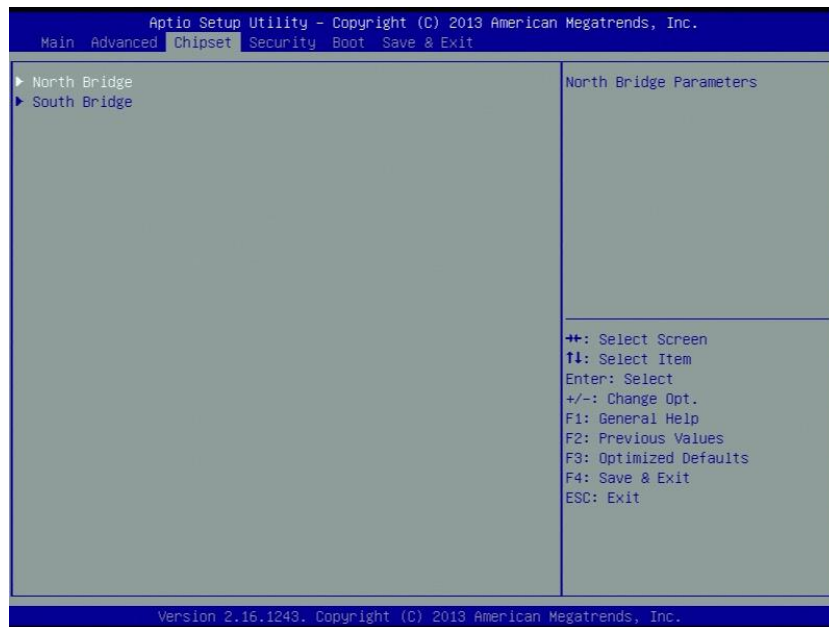

▶ **North Bridge**

Press [Enter] to view current using memory information and make settings for the following sub-items:

Intel IGD Configuration

PAVC

Use this item to enable or disable Protected Audio Video control.

The optional settings are: [Disabled]; [LITE Mode]; [SERPENT Mode].

DVMT Pre-Allocated

Use this item to select DVMT 5.0 Pre-Allocated (Fixed) Graphics Memory size used by the Internal Graphics Device.

The optional settings are: [64M]; [96M]; [128M]; [160M]; [192M]; [224M]; [256M]; [288M]; [320M]; [352M]; [384M]; [416M]; [448M]; [480M]; [512M].

DVMT Total Gfx Mem

Use this item to select DVMT 5.0 Total Graphics Memory size used by the Internal Graphics Device.

The optional settings are: [128M]; [256M]; [MAX].

Aperture Size

The optional settings are: [128MB]; [256MB]; [512MB].

GTT Size

The optional settings are: [1MB]; [2MB].

IGD Turbo Enable

The optional settings are: [Enabled]; [Disabled].

Spread Spectrum Clock

The optional settings are: [Enabled]; [Disabled].

IGD Boot Type

Use this item to select preference display interface used when system boot.

The optional settings are: [CRT]; [eDP+CRT]; [LVDS+CRT].

***Note:** In the case that 'IGD Boot Type' is set as [LVDS+CRT], user can make further settings in 'LVDS Panel Type'

LVDS Panel Type

Use this item to select LVDS panel resolution.

The optional setting are: [800 x 480 24bit Single]; [800x 600 18bit Single]; ; [800x 600 24bit Single]; [1024 x 600 18bit Single]; [1024 x 768 18bit Single]; [1024 x 768 24bit Single]; [1280 x 768 24bit Single]; [1280 x 800 18bit Single]; [1280 x 800 24bit Single]; [1366 x 768 18bit Single]; [1366 x 768 24bit Single]; [1440 x 900 18bit Dual]; [1440 x 900 24bit Dual]; [1280 x 1024 24bit Dual]; [1680 x 1050 24bit Dual]; [1920 x 1080 24bit Dual].

▶ **South Bridge**

Press [Enter] to further setting USB device configuration.

▶ **USB Configuration**

Press [Enter] to make settings for the following sub-items:

USB Configuration

USB 3.0 Support

The optional settings are: [Enabled]; [Disabled]; [Auto]; [Smart Auto].

USB 3.0 Link Power Management

The optional settings are: [Enabled]; [Disabled].

USB 2.0 Support

The optional settings are: [Auto]; [Disabled].

**Note: 'USB 2.0 Support' is only applicable when 'USB 3.0 Support' is set as 'Disabled'.*

Audio Controller

Use this item to control detection of the Azalia device.

The optional settings are: [Disabled]; [Enabled].

[Disabled]: Azalia will be unconditionally disabled;

[Enabled]: Azalia will be unconditionally enabled;

MMPE Slot Speed

The optional settings are: [Auto]; [Gen2]; [Gen1].

MPE Controller

The optional settings are: [Enabled]; [Disabled].

Speed

The optional settings are: [Auto]; [Gen2]; [Gen1].

Onboard Lan1 Controller

The optional settings are: [Enabled]; [Disabled].

Onboard Lan2 Controller

The optional settings are: [Enabled]; [Disabled].

System State after Power Failure

Use this item to select AC power state when power is re-applied after a power failure. The optional settings are: [Always Off]; [Always On]; [Former State].

3-9 Security Menu

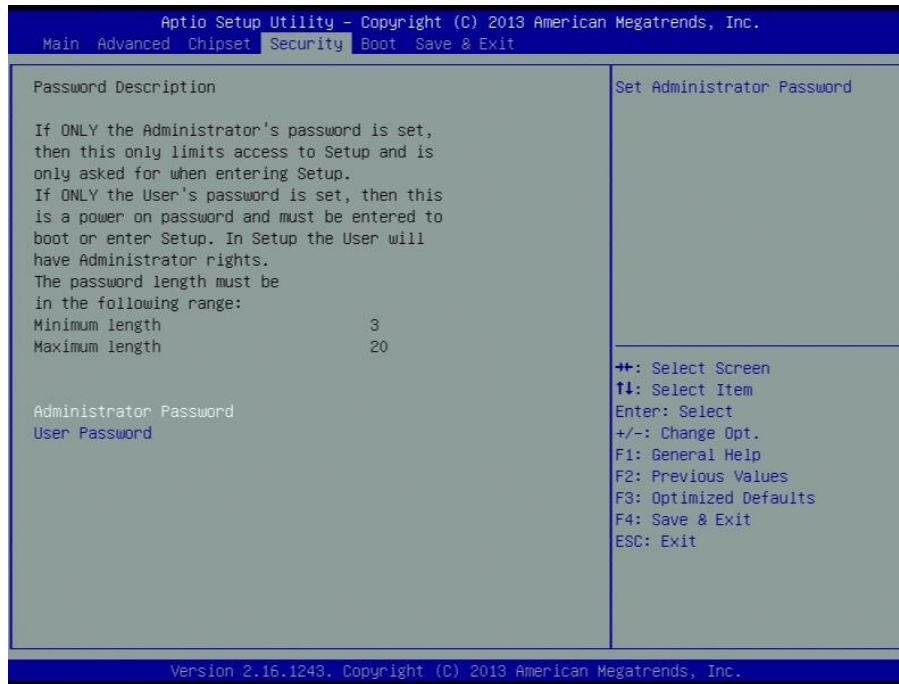

Security menu allow users to change administrator password and user password settings.

3-10 Boot Menu

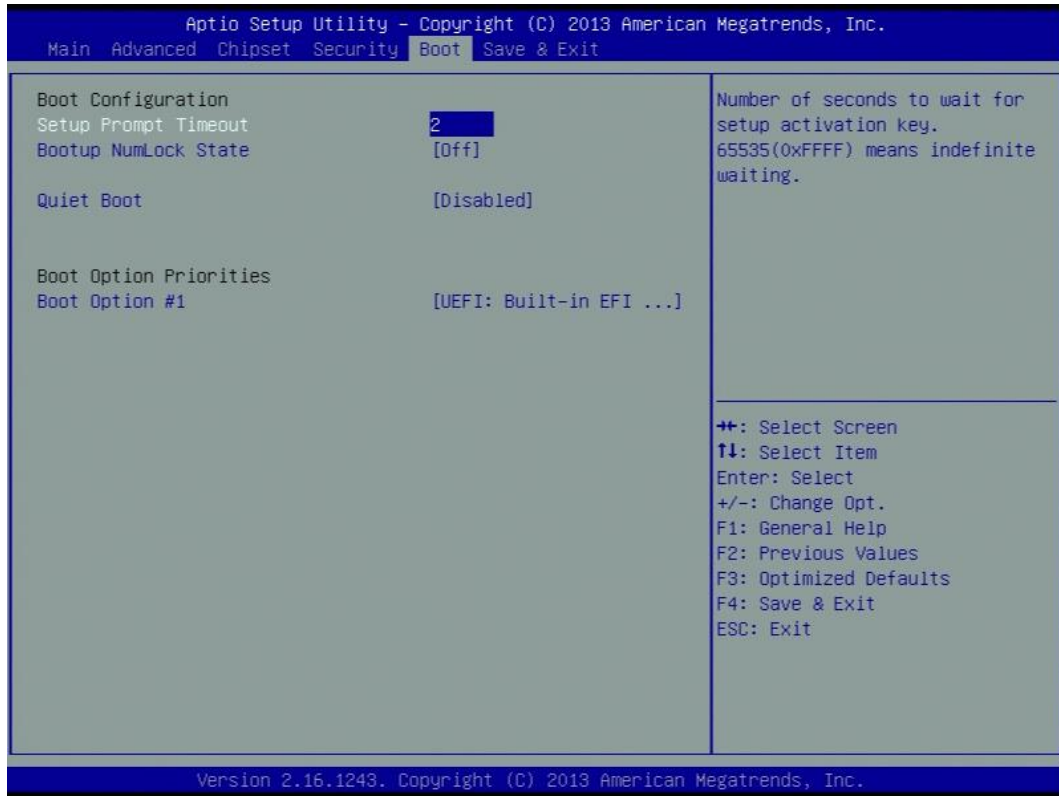

Boot Configuration

Setup Prompt Timeout

Use this item to set number of seconds to wait for setup activation key.

Bootup Numlock State

Use this item to select keyboard numlock state.

The optional settings are: [On]; [Off].

Quiet Boot

The optional settings are: [Disabled]; [Enabled].

Boot Option Priorities

Boot Option

The optional settings are: [UEFI: Built-in EFI Shell]; [Disabled].

3-11 Save & Exit Menu

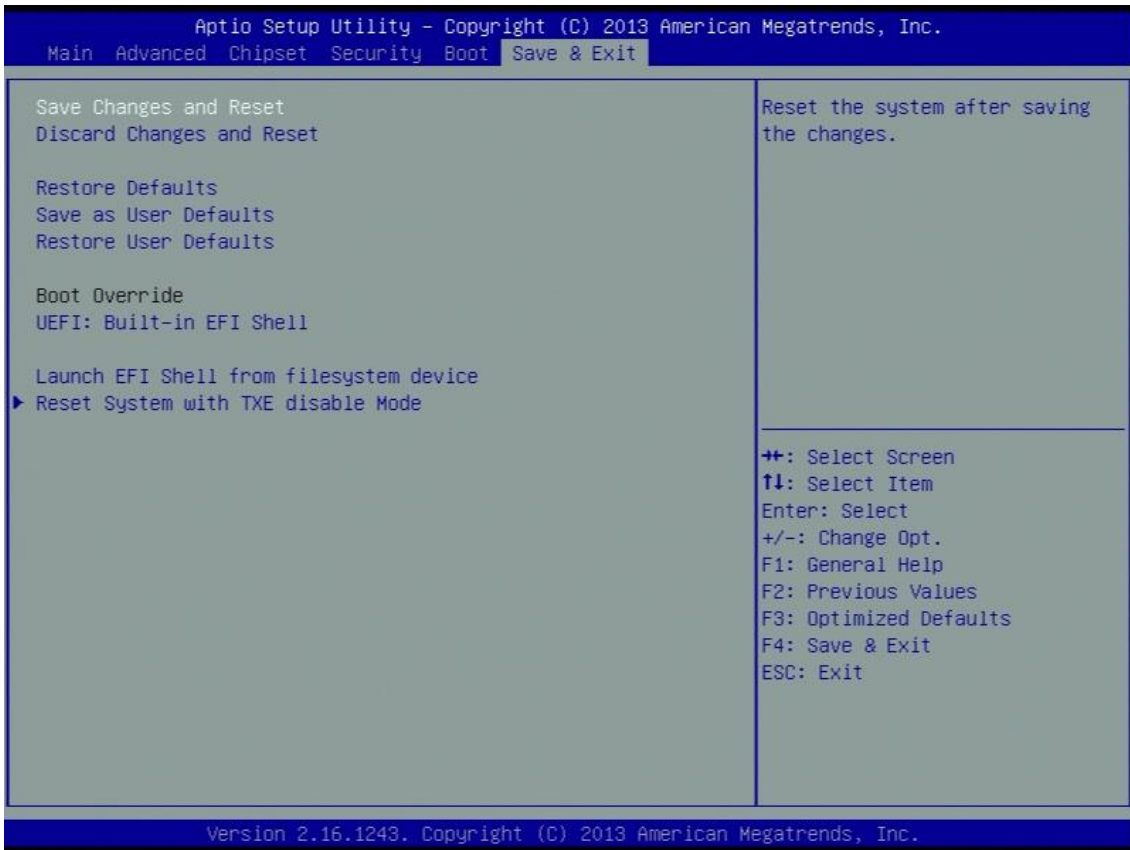

Save Changes and Reset

This item allows user to reset the system after saving the changes.

Discard Changes and Reset

This item allows user to reset the system without saving any changes.

Restore Defaults

Use this item to restore /load default values for all the setup options.

Save as User Defaults

Use this item to save the changes done so far as user defaults.

Restore User Defaults

Use this item to restore defaults to all the setup options.

Boot Override

UEFI: Built-in EFI Shell

Press this item and a dialogue box shall appear to ask if user wish to save configuration and reset.

Lauch EFI Shell from filesystem device

Use this item to launch EFI shell application (shell.efi) from one of the available filesystem device.

Reset System with TXE disable Mode

Press [Enter] for TXE to run into the temporary disable mode. Ignore if TXE Ignition FW.